

OZZY-STAINLESS STEEL BODY INGROUND LIGHT

TECHNICAL SHEET
OD-ING-055



KEYLIGHT

SPAIN

PRODUCTOS DE ILUMINACION

FEATURES

- 3W ,12V/24V
- CE ROHS Certified
- Tempered Glass Diffuser
- 3-Years Warranty

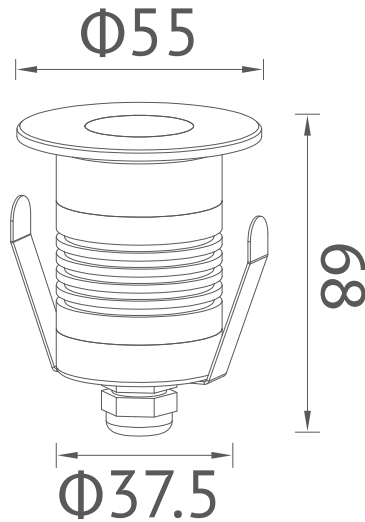

SPECIFICATIONS

Product Code	OD-ING-055
Power	3W
Input	12V/24V
Luminous Flux	150 lm
Beam Angle	15°/30°
CRI	80
Power Factor	>0.5
Material	Stainless Steel SS304
IP Rating	IP 65 Class 1
Dimensions	Ø55mm*58mm
Warranty	3 years